

BONENG



中文

**P行星齿轮箱
使用手册**

**P Planetary
Gearbox Use
Manual**

EN

01/2025

产品范围

(P2N P3N P2S P3S P2L P2K P3K)

规格范围

(07 - 36)

P. NA

P. NC

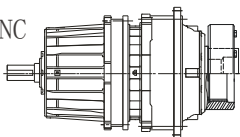

P. NB

P. ND

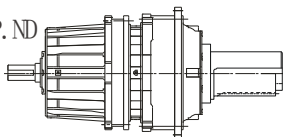

P. SA

P. SC

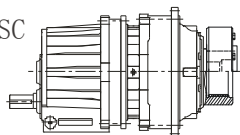

P. SB

P. SD

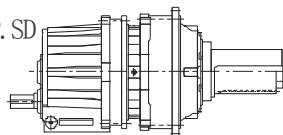

P. LA

P. LC

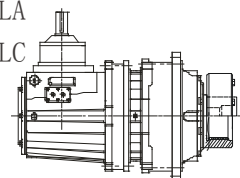

P. LB

P. LD

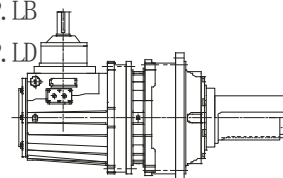

P. KA

P. KC

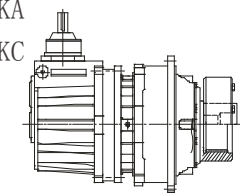

P. KB

P. KD

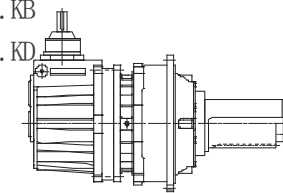

目录

重要提示	01
1 安全说明	02
2 技术说明	02
2.1 铭牌说明	02
2.2 齿轮箱的噪声水平	03
2.3 注意事项	05
3 安装与拆卸	06
3.1 安装前的注意事项	06
3.2 准备工作	06
3.3 齿轮箱的整机安装	07
3.4 联轴器的安装	09
3.5 锁紧盘的安装与拆卸	10
3.6 扭力臂的安装	11
4 安装方位	12
4.1 安装方位说明	12
4.2 安装方位页面的说明	12
4.3 齿轮箱的安装方位	12
5 润滑/冷却/加热	13
5.1 润滑	13
5.2 注油量	14
5.3 冷却	15
5.4 加热	15
5.5 逆止机构	15
6 使用	16
6.1 润滑油添加	16
6.2 设备检查	16
6.3 起动	16
7 检查与维护	17
7.1 定期检查与维护	17
7.2 检查与维护的周期	17
7.3 检查与维护的注意事项	18
8 故障处理	19
8.1 故障、原因和措施	19
售后服务	21

重要提示

在安装操作过程中，
请注意本使用手册中的安全提示和警告提示！



有电危险
可能产生的后果：死亡或者严重伤害



危险情况
可能产生的后果：轻微伤害



有害情况：
可能产生的后果：损坏传动装置和环境



使用建议和有用的信息



- ◆ 遵守本手册的规定可以让装置无故障运行，同时也满足质量缺陷索赔的要求，因此在使用传动装置进行工作之前，请您先阅读本使用手册；
- ◆ 本使用手册包含重要的安装维护提示，请将使用手册保管在靠近设备的位置，以便安装维护参阅；

1 安全说明

安全说明主要涉及齿轮箱的使用。当使用齿轮箱时，请注意手册中的相关安全提示！

- ◆使用手册为本公司所供齿轮箱的有机组成部分。
 - ◆齿轮箱的安装、操作、维护和修理人员均需认真阅读本手册并遵守其中的规定。
 - ◆严格遵循手册中的规定是实现产品无故障运行和履行任何质量保证要求的必要条件。
 - ◆在遵循手册规定的前提下还要注意：
 - 相关安全和事故防范的国家（地区）规定；
 - 相关设备的特别规定和要求；
 - 设备装置上的安全警告和安全标志牌。
 - ◆下列情况会导致人身伤害和财产损失：
 - 使用不当；
 - 安装或操作失误；
 - 违反规定拆除必要的防护罩或机壳。
 - ◆若因违反本手册的规定而造成的任何损伤或停机，本公司概不负责。
- 为不断追求技术进步，我们保留对其进行修改的权力。通过不断改进，将在保持基本特性的基础上，有利于进一步提高其使用性能和工作安全性。

2 技术说明

2.1 铭牌说明

BONENG			
Type	①		
n2	②		RPM
P1	③	kW	T2
n1	⑤	RPM	i
Oil	⑦		Wt.
NO.	⑨		Date
			⑩

铭牌上的数据十分重要，请仔细阅读，并保持其整洁，当需要服务时，请提供铭牌上的产品编号、使用时间及故障类型。

- ①产品型号
- ②输出转速（直联电机时才有）
- ③额定输入功率 kW
(直联电机时指电机功率)
- ④额定输出扭矩 N • m
- ⑤额定输入转速 RPM
(直联电机时是指电机转速)
- ⑥公称减速比
- ⑦润滑油粘度
- ⑧重量
- ⑨产品编号
- ⑩出厂日期

2.2 齿轮箱的噪声水平

- ◆ 噪声符合相关的国家标准，行业标准及企业标准；
- ◆ 噪声的检测根据声强法进行，距声源处（所检测表面噪声区域）1m的距离检测；
- ◆ 噪声水平是指齿轮箱在良好工况条件下正常运行，在标牌上规定的额定输入转速 n_1 、额定输入功率 P_1 条件下工作时，检测得到的噪声水平。
- ◆ 如果所采用的检测技术使重复测量无法得到最终结果，则应采用本公司试验台上得到的检测结果；测量表面的噪声水平不包括润滑装置附件的噪声

齿轮箱的测量表面噪声水平

类型	iN	7	8	9	10	11	12	13	14	16	17	18	19
P2N	25~40	81	81	83	83	84	84	84	85	85	85	86	86
P3N	140~280	/	/	80	80	80	80	81	81	81	81	82	82
P2S	45~56	80	80	83	84	85	87	88	90	92	93	94	95
	63~80	78	78	81	82	83	85	86	88	90	91	92	93
	90~125	76	76	79	81	82	84	85	86	89	89	90	91
P3S	280~355	/	/	74	75	76	78	79	81	82	83	84	85
	400~560	/	/	72	73	74	76	78	79	80	81	82	83
	630~900	/	/	70	71	72	74	76	77	78	79	80	81
P2L	31.5~45	80	80	83	84	85	86	88	89	90	92	93	95
	50~71	78	78	81	82	83	84	86	87	88	90	91	93
	80~100	77	77	80	81	82	83	85	86	87	89	90	92
P2K	112~160	76	76	79	81	83	85	87	89	91	92	94	95
	180~250	75	75	76	78	80	82	84	86	88	89	91	92
	280~560	72	72	73	75	77	79	81	83	85	86	88	89
P3K	560~900	/	/	70	70	72	74	76	78	80	81	82	84
	1000~1600	/	/	68	68	69	71	73	75	76	77	78	80
	1800~4000	/	/	65	65	66	68	70	72	73	74	75	77

说明:

(1)表中所列噪声水平是根据质检部统计评价结果确定的。从统计概率意义上讲, 齿轮箱将不会超过这一噪声水平。

(2)在输入转速 $n_1=1500 \text{ r/min}$ 条件下的检测表面声压水平, 允许偏差 $+3 \text{ dB (A)}$ 。当齿轮箱采用法兰联接座时, 该值将增加大约 2 dB (A) 。当转速 $n_1=750 \text{ r/min}$ 时, 检测值将降低大约 $2-3\text{dB (A)}$ 。

(3)当噪声水平 (db) 超过允许的最大值时, 可以采用吸音罩罩住。

20	21	22	23	24	25	26	27	28	29	30	31	32	33	34
86	87	87	87	87	87	87	87	87	87	88	88	88	88	88
82	83	83	83	83	84	84	84	84	84	84	85	85	85	85
95	97	97	98	98	99	99	100	100	101	101	102	102	103	103
93	95	95	96	96	97	97	98	98	99	99	100	100	101	101
91	93	93	94	94	95	95	96	96	97	97	98	98	99	99
86	87	87	88	88	89	89	90	90	91	91	92	92	93	93
84	85	85	86	86	87	87	88	88	89	89	90	90	91	91
82	83	83	84	84	85	85	86	86	87	87	88	88	89	89
95	96	96	97	97	98	98	99	99	100	100	101	101	102	102
93	94	94	95	95	96	96	97	97	98	98	99	99	100	100
92	93	93	94	94	95	95	96	96	97	97	98	98	99	99
96	-	-	-	-	-	-	-	-	-	-	-	-	-	-
93	-	-	-	-	-	-	-	-	-	-	-	-	-	-
90	-	-	-	-	-	-	-	-	-	-	-	-	-	-
85	86	87	88	88	90	90	91	91	92	92	-	-	-	-
81	82	83	84	84	86	86	87	87	88	88	-	-	-	-
78	79	80	81	81	82	82	83	84	85	85	-	-	-	-

2.3 注意事项

(下述注意事项与齿轮箱的使用有关)

- ◆除订货合同中另外有所规定，否则齿轮箱不得储存或工作在强酸、强碱、低温、高温和重度的空气污染、潮湿以及具有化学物品的场所。
- ◆不得用高压清理设备清洁齿轮箱外表；
- ◆搬运时要特别小心，防止轴端被撞击，否则将有可能造成齿轮箱的损坏。在吊运齿轮箱时，不得使用轴端螺纹安装吊环后作为起吊点；
- ◆要遵守齿轮箱上所附加的说明，例如铭牌、指示方向的箭头等。这些铭牌和标记上面不得被油漆或污垢覆盖；
- ◆外漏的旋转的零部件，例如联轴器，液力耦合器，齿轮，驱动皮带轮等，必须配备合适的防护罩，以防止人员的意外接触；
- ◆对齿轮箱所进行检修、保养、维护、安装都必须在齿轮箱不工作的情况下进行；
- ◆不得在齿轮箱上进行焊接工作，也不得用作焊接工作的接地点。焊接会造成精密轮齿和轴承不可修复的损坏；
- ◆在组装或者拆卸工作中损坏了的螺栓，一定要用同等强度和类型的新螺栓更换；
- ◆如果在齿轮箱的运行过程中发现了任何异常现象（例如过热或者不正常的噪声等），应该立即关断驱动装置。
- ◆配件一定要从 BONENG 公司购买。
- ◆对于不合理使用联轴器、私自对齿轮箱进行修改、以及使用非本公司零部件的情形，所造成的不良后果不在三包服务之内。

3 安装与拆卸

3.1 安装前的注意事项



- ◆ 确认齿轮箱完好无损（在运输或储存过程中未损坏）。
- ◆ 确认现场环境条件与铭牌内容相符。标准齿轮箱使用环境温度为。 -20°C ~ $+50^{\circ}\text{C}$ ；无油、酸、有害气体、蒸汽、放射性物质等。
- ◆ 若齿轮箱储存时间在一年以上，轴承内润滑剂的使用寿命将缩短。



- ◆ 在户外安装时应该避免阳光直射，一定要避免热力集中影响齿轮箱的正常性能。
- ◆ 特殊形式齿轮箱：是根据环境条件配置的。
- ◆ 在进行规划阶段就应该预留足够的空间进行维护保养和修理工作。
- ◆ 配备了风扇的齿轮箱，应该有足够的空间以便能够吸入空气。

3.2 准备工作

- ◆ 彻底清除输出输入轴和法兰表面的防腐剂、污物等；注意不要让溶剂浸入并损坏油封。
- ◆ 工具/材料的准备：一组扳手、扭矩扳手、装配夹具、输入和输出紧固装置、润滑剂(防锈油)、密封螺栓的介质(螺纹锁固剂)。

3.3 齿轮箱的整机安装

基础

- ◆ 准备刚性好的基础或牢固的台架来安装传动设备，适合于齿轮箱的重量和扭矩，并且要考虑作用在齿轮箱上的力。同时也需充分考虑即使加上最大载荷，也不至于改变装配好后各部件的位置。
- ◆ 齿轮箱的基础应该水平并平整。基础的设计应该保证不会产生谐振并且不会有临近的基础传递过来的振动。
- ◆ 底脚安装六角头螺栓和螺母应该紧固到规定的扭矩。我们推荐强度级别为8.8或者更高强度的螺栓。

吊装位置

齿轮箱如果带有锁紧盘，在吊运前锁紧盘必须轴向固定

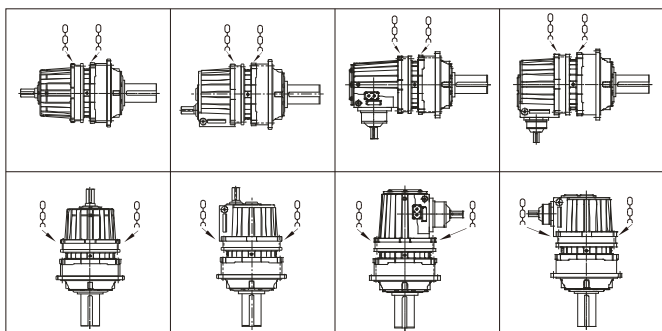

⚠ 注：禁止使用轴端螺纹安装吊环后做为起吊点。

根据各种不同安装形式还需注意：

- ◆底座式安装时应校准中心高，联轴器联接时应校准两轴的同轴度；柔性联轴器时浮动量不超过联轴器的允许范围，刚性联接时保证各安装联接的形位公差；长轴联接还要考虑轴的足够刚度。
- ◆法兰式安装时，凸肩（或凹肩）应配合良好，以免错位。法兰式安装并配空心轴联接时，特别应保证联接的形位公差。
- ◆齿轮箱的输入轴和输出轴加装皮带轮或链轮时，必须使皮带轮或者链轮传力部位尽量靠近轴肩。如下图所示：
- ◆使用合适上升降装置利用轴端螺纹孔，压入连接件，严禁直接使用锤子敲击。

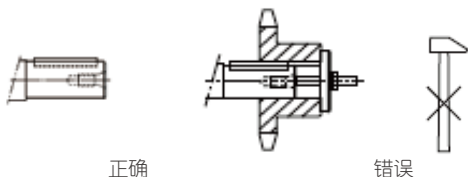

- ◆皮带轮或链轮安装时，应保证输入轴和驱动装置精密对中，保证图示位置的四个对点最大轴向变动允差值为每1000mm变动1mm。

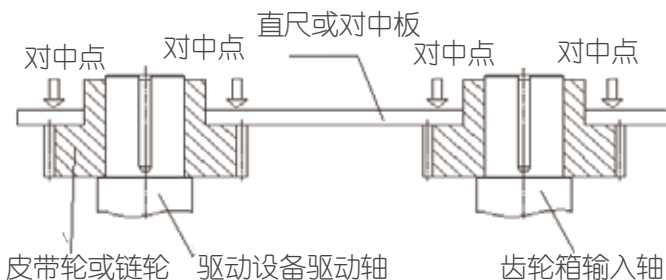

- ◆皮带轮或链轮安装时，应保证皮带和链条有一定的张紧力。



3.4 联轴器的安装

- ◆ 齿轮箱的输入端的驱动装置应该采用弹性联轴器或者液力耦合器。
- ◆ 当齿轮箱的输出轴是实心轴的时候，同样也应该使用弹性联轴器。
- ◆ 如果要使用刚性联轴器或者其它会产生额外的径向力或轴向力的输入和输出零部件的话（例如齿轮、皮带轮、飞轮、液力耦合器等），都应该在合同中注明。
- ◆ 输入轴与驱动轴安装联接时，必须保证输入轴和驱动轴同轴心。同轴度误差大会增大机械振动，导致轴承过早破坏并且影响齿轮接触。如下图所示，输入轴与驱动轴通过联轴器安装后，必须用表找正，有关检测参数推荐满足下表《同轴精度表》要求后，设备方可生产运行。

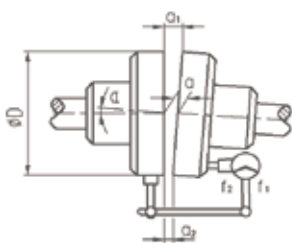

角度偏差检测

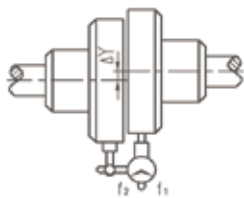

偏移检测

同轴精度表

外径D	n<500r/min		500-1500r/min		>1500r/min	
	a1-a2	ΔY	a1-a2	ΔY	a1-a2	ΔY
$D \leq 100$	0.05	0.05	0.04	0.04	0.03	0.03
$100 < D \leq 200$	0.06	0.06	0.05	0.05	0.04	0.04
$200 < D \leq 400$	0.12	0.10	0.10	0.08	0.08	0.06
$400 < D \leq 800$	0.20	0.16	0.16	0.12	0.12	0.10



说明：

当联轴器外径的圆周速度在30m/s及以下时，一定要进行静平衡。当外径圆周速度超过30m/s 时就要进行动平衡。

3.5 锁紧盘的安装与拆卸

- ◆当齿轮箱空心轴配置锁紧盘时，应先在空心轴上套上锁紧盘，再按上述方法完成被驱动设备的驱动轴的安装，在安装被驱动设备的驱动轴之前不要拧紧锁紧盘上的紧固螺栓。



→所供货的锁紧盘是可直接安装的，在首次受力之前一定不能拆卸下来。

→安装锁紧盘前，要确保空心轴孔和被驱动设备的驱动轴在锁紧盘区域不能有润滑油。

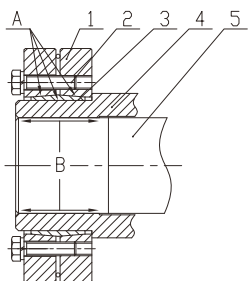

- 1外环
- 2紧固螺栓
- 3内环
- 4空心轴
- 5被驱动轴
- A有润滑脂的部位
- B绝对不能有润滑脂的部位

- ◆拧紧锁紧盘上的螺栓时，严禁按相邻顺序逐个拧紧，应按锁紧盘安装要求，按等边三角形顺序逐次拧紧紧固螺栓，每次循环拧紧过程中，每个螺栓只能拧紧螺丝的1/4圈。
- ◆如果有高温或者振动冲击等情况，请在螺纹连接处作好防松措施。各个紧固螺栓的拧紧扭矩见下表：

螺栓	螺栓拧紧力矩		螺栓	螺栓拧紧力矩	
	强度等级 10.9 Nm	强度等级 12.9 Nm		强度等级 10.9 Nm	强度等级 12.9 Nm
M6	12	14.5	M20	470	570
M8	29	35	M24	820	980
M10	58	70	M27	1210	1450
M12	100	121	M30	1640	1970
M14	160	193	M33	2210	2650
M16	240	295	M36	2850	3420

- ◆配置了锁紧盘的齿轮箱空心轴拆卸时，锁紧盘松开的过程与紧固的方向相反，拆掉锁紧盘后再按上述方法完成被驱动设备驱动轴的拆卸。

拆卸锁紧盘时应注意：



→拆卸时严禁按照相邻的顺序松开螺栓。

→锁紧盘外环与内环难以分离时，可将几个螺栓拧入拆卸螺丝孔，将内环和外环顶开。

3.6 扭力臂的安装

- ◆所有安装在轴上的齿轮箱，必须吸收由设备力矩产生的作用在箱体上方向相反的反力矩。

单向扭力臂

- ◆在采用单向扭力臂时，应使用向心关节轴承或挠性衬套。

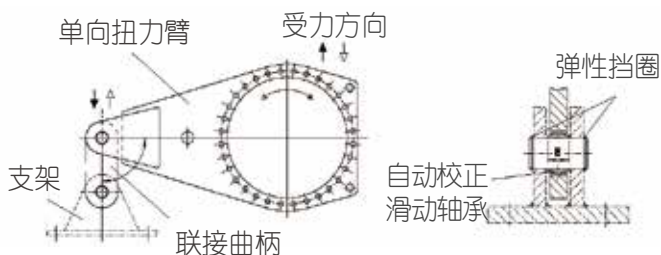

如需齿轮箱的详细资料，请参阅齿轮箱祥光技术文件中的图纸。

中文

扭转轴支架

在采用扭转轴支架时，扭矩将由杆件和装在扭转轴上的联轴节承载。这种结构形式可确保设备轴承不承受任何剪应力，自身重量除外。下图给出可能的结构形式。

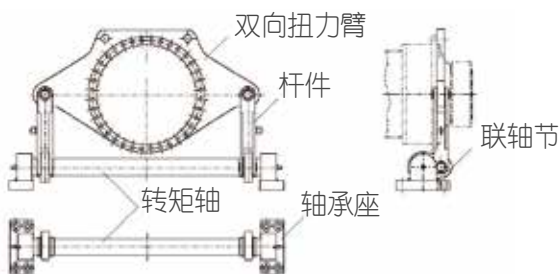

如需齿轮箱的详细资料，请参阅齿轮箱技术文件中的图纸。

轴承底座即可安装在垂直墙壁上（如图所示），也可安装在水平的基础上。



4 安装方位

4.1 安装方位说明

齿轮箱的具体安装方位及选型可参见BONENG公司产品选型手册。











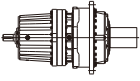
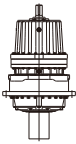
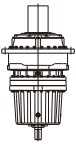

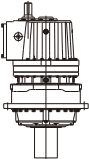
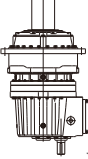

4.2 安装方位页面的说明

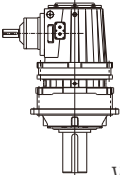
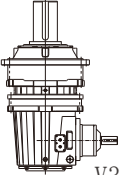
齿轮箱的安装方位页面中使用的图形符号及其含义

图形符号		含义	
		通气帽	进油孔
		油 镜	
		放油孔	

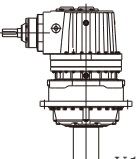
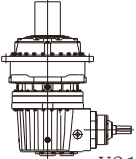
4.3 齿轮箱的安装方位

可将齿轮箱安装在不同的位置，下图给出了这些安装位置和相应的标识号：

水平安装		垂直安装	
1 同轴式 齿轮箱	P. N.  B5	 V1	 V3
2 斜齿- 行星 齿轮箱	P. S.  B51*	 V11	 V31
	 B52		
	 B53		
	 B54		
3 锥齿- 行星 齿轮箱	P. L.  B51*	 V11	 V31
	 B52		
	 B53		
	 B54		
4 锥齿- 斜齿- 行星 齿轮箱	P. K.  B51*	 V11	 V31
	 B52		
	 B53		
	 B54		

5 润滑/冷却/加热

5.1 润滑

润滑油的选择：

- ◆在相同粘度等级和类型的前提下，您可以自由地选择国际知名品牌的润滑油。如需改变推荐的粘度等级敬请垂询。
- ◆下表列出了产品规格对应使用润滑油牌号及使用环境温度。

环境温度	-20℃ ~+40℃
粘度牌号	VG320



- 环境温度低于-10℃时必须使用合成油。
- 为确保产品的使用寿命，实际使用中推荐使用合成油。
- 使用环境温度超过上述范围时，请咨询BONENG公司技术部门。

润滑油的注油量

- ◆本注油量为建议值。根据齿轮箱级数和速比的不同，相应加油量也不同。请注意油尺刻度作为加油量多少的指示。

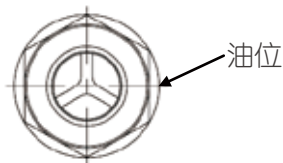

- ◆下表列出了对于安装方位相应的润滑油注油量建议值。

5.2 注油量

油量表(L)							
规格	P2N..	P2L..	P2S..	P2K..	P3N..	P3S..	P3K..
07	4	4	4	4	1	1	1
08	5	5	5	5	1	1	1
09	6	6	6	6	7	7	7
10	8	8	8	8	9	9	9
11	12	12	12	12	13	13	13
12	16	16	16	16	17	17	17
13	20	20	20	20	21	21	21
14	32	32	32	32	33	33	33
16	40	40	40	40	42	42	42
17	56	56	56	56	60	60	60
18	66	66	66	66	70	70	70
19	82	82	82	82	85	85	85
20	75	75	75	75	75	75	75
21	110	110	110		115	115	115
22	95	95	95		105	105	105
23	150	150	150		155	155	155
24	125	125	125		135	135	135
25	190	190	190		195	195	195
26	160	160	160		170	170	170
27	245	245	245		250	250	250
28	205	205	205		220	220	220
29	305	305	305		310	310	310
30	255	255	255		280	280	280
31	380		380		390	390	
32	315		315		360	360	
33	460		460		470	470	
34	380		380		480	480	
35	645		645				
36	535		535				

注:1)在环境温度-10℃~+40℃时, P系列润滑油牌号为VG320(ISO粘度等级), 附件代号为V32;

2)2)以上表格中齿轮箱油量为水平安装时的参考油量, 垂直安装时的参考油量约为表格对应数据的两倍;

5.3 冷却

根据工况条件，行星齿轮箱可配备油-水冷却器或油-气冷却器，所需要的冷却水需要由用户提供。

为确保最佳冷却性能，必须符合冷却装置规定的液体流动方向。冷却水进口和出口不得颠倒。冷却水压力不得超过8 bars。

如果齿轮箱在较长一段时间内停止运行，或者存在冷却水冻结的可能，则必须将冷却水排放干净。此时可利用压缩空气将残留在冷却器内的水吹出。

5.4 加热

对标准齿轮箱：使用环境 $-20^{\circ}\text{C} \sim +50^{\circ}\text{C}$ ，当环境温度低于 -10°C 时需要预热或空载启动，当齿轮箱温度超过 -10°C 时允许加载运行。

5.5 逆止机构

某些使用场合要求齿轮箱配备机械式止回机构。这可以让齿轮箱在运行的过程中只能朝向一个方向旋转，而旋转的方向是用箭头在齿轮箱的输入和输出端标记出来的。止回机构是安装在齿轮箱的安装法兰盘上的并且是密封不漏油的，它和润滑油循环系统形成一个整体。

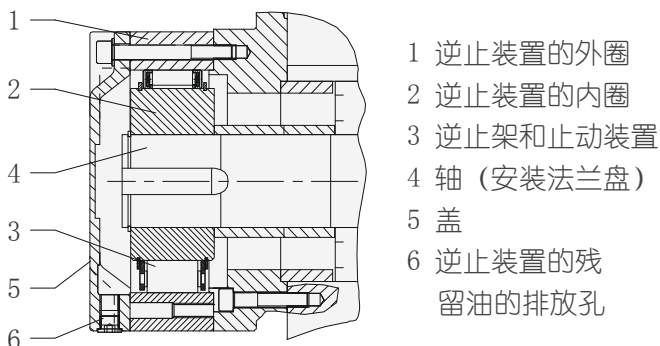

- 1 逆止装置的外圈
- 2 逆止装置的内圈
- 3 逆止架和止动装置
- 4 轴（安装法兰盘）
- 5 盖
- 6 逆止装置的残留油的排放孔

⚠ 注意：

为了避免损坏止回装置或者齿轮箱，电机不得朝向禁止转动的方向旋转，注意齿轮箱上的说明。在电机接线之前要先用相序指示计确定三相电源的旋转方向并按照规定旋转方向连接电机的接线。

6 使用

6.1 润滑油添加

- ◆ 公司产品一般都未带润滑油出厂，在设备运行前请先按使用说明书加润滑油。



在标记有该符号的位置上将通气帽拧出，



给齿轮箱加入润滑油。

6.2 设备检查

- ◆ 检查油面高度，润滑油冷却或者供油系统管路的密封性。
- ◆ 检查冷却装置，截止阀的开启状态。
- ◆ 配备了止回装置的齿轮箱，检查电机接线是否正确。
- ◆ 检查轴封是否有效。
- ◆ 检查旋转的零部件是否与其它零件接触。

6.3 启动

- ◆ 配置了电机油泵的齿轮箱应当保证在启动设备前首先开启油泵电机。
- ◆ 检查自由状态下转动方向是否正确（同时监听轴转动时是否有异常研磨噪声）。
- ◆ 运行检查时要保证轴上没有输出元件，同时开启相关的监测和保护设备。
- ◆ 无论什么时候，只要怀疑出现了不正常的运行现象（例如 温升、噪声、振动等异常），应立即关掉电机，并查明原因。
- ◆ 必要时与BONENG公司联系。

7 检查与维护

7.1 定期检查与维护

- ◆用户要定期对齿轮箱进行维护和保养，要定期检查润滑油的使用状态，定期清理通气帽、风扇、冷却盘管和齿轮箱表面的灰尘和异物，保持齿轮箱清洁，保证齿轮箱的正常运行。

7.2 检查与维护的周期

检查油温	每日
检查齿轮箱的不正常的噪声	每日
检查油面高度	每月
检查齿轮箱的漏油	每月
检验油中的水分	在400工作小时后, 至少每年一次
在起动之后的首次换油	在400工作小时后
其后的换油	每5000工作小时
清理滤油器	每3个月
清理通气帽	每3个月
清理风扇、风扇罩和齿轮箱箱体	和换油同时进行
检查润滑油空气冷却器	和换油同时进行
检查润滑油水冷却器	和换油同时进行
检查紧固螺栓的紧固程度	第一次换油后, 其后每隔一次换油
对于齿轮箱的全面检查	大约每2年和换油同时进行
清理通气螺丝	每3个月

 所列出的期限是取决于齿轮箱的工作条件的。这些期限是在如下条件下的平均值：

- 每日的工作时间24小时
- 负载系数100%
- 输入装置的转速1500 RPM
- 最高温度90℃（仅仅限于矿物油）
- 100℃（仅仅限于合成油）

7.3 检查与维护的注意事项

- ◆切断电源，防止触电，等待齿轮箱冷却。
- ◆油位的检查：油位必须在油镜的中间位置。
- ◆油的检查：移去油塞，取油样，检查油的粘度指数；如果油明显浑浊，建议尽快更换。
- ◆油的更换：
 - 不同的润滑剂禁止相互混合使用。
 - 冷却后油的粘度会增大，放油困难，换油时齿轮箱应保持温热。
 - 在油塞下面放一个接油盘，拆下油塞/通气帽，将油全部排除后装上油塞。
 - 注入同牌号的新油，油量应与安装方位一致（见铭牌）；若牌号不同则向我司售后服务咨询。
 - 在油镜处检查油位，装上通气帽。

8 故障处理

8.1 故障、原因和措施

维修工作一定要由经过培训后素质合格的人员谨慎地进行

故障	原因	措施
在齿轮箱的紧固件处有大的噪声	紧固件松动	紧固螺栓/螺母 更换损坏螺栓/螺母
齿轮箱的噪声变化	齿轮箱的齿轮发生损坏	更换损坏齿轮
	轴承间隙过大	调整轴承间隙
	轴承损坏	更换损坏轴承
工作温度过高	箱体里面的油面过高	检查并调整油面高度
	油过于陈旧	检查换油时间并更换
	油受到严重污染	换油
	冷却剂流量异常	调节管道阀门 检查水冷装置自由流量
	冷却剂温度过高	检查温度并按需调节
	水冷装置滤油器堵塞	清理滤油器
	油泵的机械故障	检查并更换油泵
	风扇盖/箱体严重污染	清理风扇盖和箱体。

故障	原因	措施
轴承处的温度过高	箱内油面异常	调整油面高度
	油过于陈旧	检查、更换新油
	油泵的机械故障	修理/更换油泵
	轴承损坏	查阅标准振动数据 检查/更换轴承
轴承处的振幅升高	轴承损坏	检查/更换轴承
	齿轮损坏	检查/更换齿轮
止回装置温度过高/功能失效	止回装置损坏	检查/更换止回装置
齿轮箱漏油	密封不良	检查并更换新油封 重新密封连接处
	径向轴封环失效	更换径向密封
油中有水	油中有杂物	检查油中是否存在水分
	冷却器/冷却盘管失效	检查/修理泄漏处 更换冷却器/冷却盘管
	齿轮箱凝霜	用保温材料保护齿轮箱 避免冷空气直吹齿轮箱
压力监测装置报警	油压<0.5巴	检查油面高度，按需加油 检查/更换滤油器 检查油泵功能 修理/更换油泵
双切换式滤器的指标器发出警报	双切换式滤器堵塞	切换切换滤器 清理堵塞滤芯
供油系统的故障		查看供油系统说明

对于客户自己无法排除的故障请和我公司售后服务部联系。

售后服务

售后服务请按以下步骤提交售后流程。

- 登录 “www.boneng.com”
- 点击 “服务” 和 “售后服务”

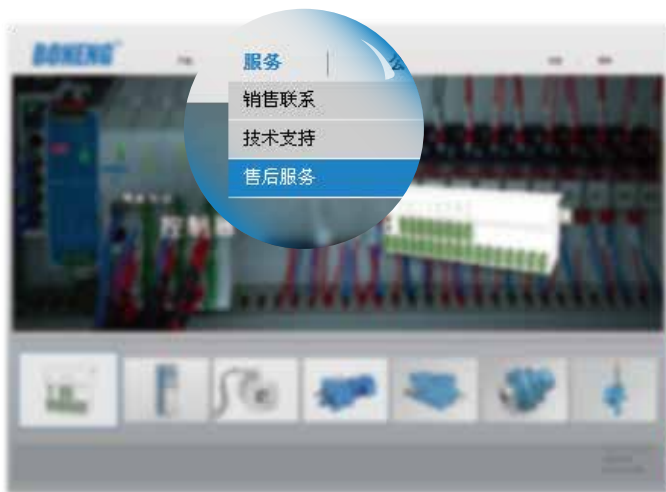

中文

- 登录系统

[邮箱登录](#)

[新用户注册](#)

请输入合法邮箱

请输入密码

请输入验证码



登录

其他地区

控制器/驱动器 : 0512-66182005

马达/齿轮马达/齿轮箱 : 0512-66189918

博能传动（沈阳）有限公司

控制器/驱动器：024-31271571

马达/齿轮马达/齿轮箱：024-31292571

博能传动（天津）有限公司

控制器/驱动器：022-86928559

马达/齿轮马达/齿轮箱：022-26929558

博能传动（开封）有限公司

控制器/驱动器：0371-23335230

马达/齿轮马达/齿轮箱：0371-23277771

博能传动（潍坊）有限公司

控制器/驱动器：0536-4699687

马达/齿轮马达/齿轮箱：0536-4699667

博能传动（长沙）有限公司

控制器/驱动器：0731-88386958

马达/齿轮马达/齿轮箱：0731-88380725

博能传动设备（成都）有限公司

控制器/驱动器：028-87740066

马达/齿轮马达/齿轮箱：028-87740066

博能传动（肇庆）有限公司

控制器/驱动器：0757-86719757

马达/齿轮马达/齿轮箱：0758-2699830

博能传动（苏州）有限公司

控制器/驱动器 苏南区：0512-66182005

马达/齿轮马达/齿轮箱 苏南区：0512-66189918

控制器/驱动器 浙沪区：0512-66182005

马达/齿轮马达/齿轮箱 浙沪区：0512-66189918

控制器/驱动器 苏皖区：0512-66182005

马达/齿轮马达/齿轮箱 苏皖区：025-52171612

博能传动（美国）有限公司

技术支持/调试/售后服务：

1250 E 222nd Euclid, OH 44117, United Staes

Email: America@boneng.com

Tel: 1-216-618-3099/1-216-618-0138

博能传动（印度）有限公司

技术支持/调试/售后服务：

Plot No. E-10/3, MIDC sinnar (Malegaon) Industrial Area,
Nashik, 422123, Maharashtra, India.

Email: india@boneng.com

Tel: +91-11-4507 6293/+91-22-2781 3385

Product range:

(P2N P3N P2S P3S P2L P2K P3K)

Size range

(7 - 36)

P.NA
P.NC

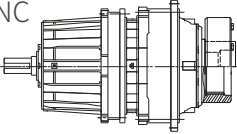

P.NB
P.ND

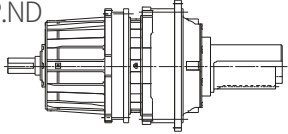

P.SA
P.SC

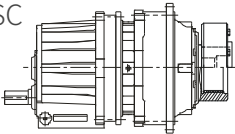

P.SB
P.SD

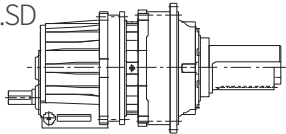

P.LA
P.LC

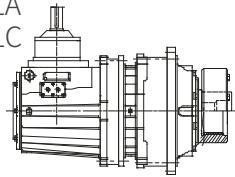

P.LB
P.LD

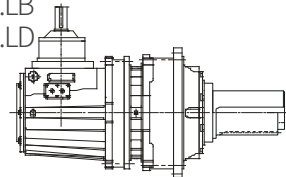

P.KA
P.KC

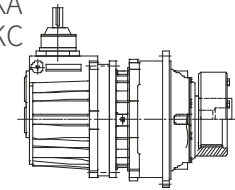

P.KB
P.KD

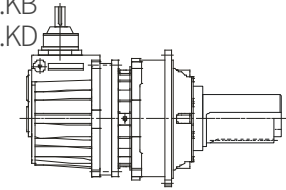

Contents

Important notes	23
1 Safety information	24
2 Technical information	24
2.1 The name plate information	24
2.2 Noise level of the gearbox	25
2.3 Notes	27
3 Installation and dismantlement	28
3.1 Notes before installation	28
3.2 Preparations	28
3.3 Installation of gearbox	29
3.4 Assembly of coupling	31
3.5 The installation and teardown of locking plate	32
3.6 Torque reaction arm installation	33
4 Mounting position	34
4.1 General description of mounting position	34
4.2 Specified description of mounting position	34
4.3 Identification of gearbox mounting position	35
5 Lubrication/Cooling/Heating	36
5.1 Lubrication	36
5.2 Oil quantity	37
5.3 Cooling	38
5.4 Heating	38
5.5 Backstop	38
6 Application	39
6.1 Fill the lubrication oil	39
6.2 Check the device	39
6.3 Start	39
7 Checks and maintenance	40
7.1 Check and maintenance regularly	40
7.2 Periods of checks and maintenance	40
7.3 Notes for checks and maintenance	41
8 Fault treatment	42
8.1 Fault reason and measures	42
After-sales service	45

Important notes

During installation, please pay attention to the safety notes and warning in this book!



Electricity danger
Possible result: death or serious injury



Dangerous situations
Possible result: minor injury



Harmful situations:
Possible result: damage transmission device and the environment



Application suggestions and useful information



- ◆ If you conform to the regulations in this manual, there won't be any fault, at the same time, it can satisfy the requirements of quality defect claim. So before the transmission device starts working, please read this instruction.
- ◆ This instruction book contains important installation and maintenance notes, please keep this instruction book in a place near the device for reference.

1 Safety information

Safety information mainly involve the applications of gearbox. When running gearbox, please note the relevant notes.

- ◆ This instruction is an integral part of the gearbox supplied.
- ◆ All persons involved in the installation, operation, maintenance and repair of the gearbox must have read the instructions and comply with them.
- ◆ Conforming to the instruction strictly is a necessity for realizing non-fault running and performing any quality assurance requirement.
- ◆ Under the premise of conforming to instruction, please pay attention to:
 - National (Local) regulations for relevant safety and accident preventions;
 - Special regulations and requirements of relevant devices;
 - Warning and safety mark on device.
- ◆ The following situations will cause human injury and property loss:
 - Incorrect running;
 - Wrong installation or operation;
 - Dismatle the protect cover or housing against the instructions.
- ◆ Any damage or stop caused by disregarding this instruction book will not be responsible by the company.
- ◆ To seek for technical advance, we reserve the rights to modify the instructions. With continuous improvements, we will further improve its performance and safety performances on the foundation of keeping the basic characteristics.

2 Technical information

2.1 The name plate information

BONENG			
Type			
n ₂		RPM	
P ₁	kW	T ₂	N · m
n ₁	RPM	i	
Oil		Wt.	kg
NO.	Date		

Data on nameplate are very important, please read them carefully and keep them clean. When services are needed, please provide the product number, used time and fault details.

- ① Product type
- ② Output speed (only for directly connected motor)
- ③ Rated input power kW (it means motor power for directly connected motor)
- ④ Rated output torque N · m
- ⑤ Rated input speed RPM (it means motor speed for directly connected motor)
- ⑥ Nominal ratio
- ⑦ Lubrication oil viscosity
- ⑧ Weight
- ⑨ Product number
- ⑩ Production date

2.2 Noise level of gearbox

- ◆ Noise level conforms to relevant national standard, industrial standard and enterprise standard.
- ◆ Inspection of noise is done according to sound density theory, it is inspected in a distance of 1 meter (the surface noise region).
- ◆ Noise level is tested when gearbox is under good working situation with regulated rated input speed n_1 and rated input power p_1 stated on the name plate. If several figures are given, the highest speed and power values apply.
- ◆ If the repeated measurement can't get the final result, you should apply the inspection result obtained from the test platform of our company.

Measurement of surface noise level doesn't include the noise of accessories of lubrication device

LPA Measuring-surface noise level LPA in db(A)

Type	iN	7	8	9	10	11	12	13	14	16	17	18	19
P2N	25~40	81	81	83	83	84	84	84	85	85	85	86	86
P3N	140~280	/	/	80	80	80	80	81	81	81	81	82	82
P2S	45~56	80	80	83	84	85	87	88	90	92	93	94	95
	63~80	78	78	81	82	83	85	86	88	90	91	92	93
	90~125	76	76	79	81	82	84	85	86	89	89	90	91
P3S	280~355	/	/	74	75	76	78	79	81	82	83	84	85
	400~560	/	/	72	73	74	76	78	79	80	81	82	83
	630~900	/	/	70	71	72	74	76	77	78	79	80	81
P2L	31.5~45	80	80	83	84	85	86	88	89	90	92	93	95
	50~71	78	78	81	82	83	84	86	87	88	90	91	93
	80~100	77	77	80	81	82	83	85	86	87	89	90	92
P2K	112~160	76	76	79	81	83	85	87	89	91	92	94	95
	180~250	75	75	76	78	80	82	84	86	88	89	91	92
	280~560	72	72	73	75	77	79	81	83	85	86	88	89
P3K	560~900	/	/	70	70	72	74	76	78	80	81	82	84
	1000~1600	/	/	68	68	69	71	73	75	76	77	78	80
	1800~4000	/	/	65	65	66	68	70	72	73	74	75	77

Note:

(1) The sound level stated in the table was obtained by statistical calculation by our QC. The gearbox may be expected to comply with these sound levels with statistical probability.

(2) The measuring surface sound pressure levels shown apply with a tolerance of +3 dB(A) for $n_1=1500$ r/min. At $n_1=750$ r/min, the values will be approximately 2-3 dB(A) lower.

(3) When the measuring-surface sound level exceeds the maximum value, the noise absorption must be applied.

20	21	22	23	24	25	26	27	28	29	30	31	32	33	34
86	87	87	87	87	87	87	87	87	87	88	88	88	88	88
82	83	83	83	83	84	84	84	84	84	84	85	85	85	85
95	97	97	98	98	99	99	100	100	101	101	102	102	103	103
93	95	95	96	96	97	97	98	98	99	99	100	100	101	101
91	93	93	94	94	95	95	96	96	97	97	98	98	99	99
86	87	87	88	88	89	89	90	90	91	91	92	92	93	93
84	85	85	86	86	87	87	88	88	89	89	90	90	91	91
82	83	83	84	84	85	85	86	86	87	87	88	88	89	89
95	96	96	97	97	98	98	99	99	100	100	101	101	102	102
93	94	94	95	95	96	96	97	97	98	98	99	99	100	100
92	93	93	94	94	95	95	96	96	97	97	98	98	99	99
96	-	-	-	-	-	-	-	-	-	-	-	-	-	-
93	-	-	-	-	-	-	-	-	-	-	-	-	-	-
90	-	-	-	-	-	-	-	-	-	-	-	-	-	-
85	86	87	88	88	90	90	91	91	92	92	-	-	-	-
81	82	83	84	84	86	86	87	87	88	88	-	-	-	-
78	79	80	81	81	82	82	83	84	85	85	-	-	-	-

2.3 Notes

(Following notes is related to the use of gearbox)

- ◆ Unless there are other regulations in ordering contract , gearbox should not be stored or work in sites with strong acid , alkali , low temperature , high temperature and heavy polluted air , damp and the places with chemical articles .
- ◆ The gearbox must not be cleaned using high - pressure cleaning equipment .
- ◆ When shifting the gearbox , take care to avoid the shaft ends knocked , otherwise the gearbox may be damaged . When lifting , don ' t use the front threads at the shaft ends to attach eyebolts for transport .
- ◆ You should conform to the instructions on gearbox , for example , nameplate , arrow of the direction , etc . These nameplates and marks must be kept free from dirt and paint out all times .
- ◆ All the rotating components should be equipped with protective cover to prevent accidental contact of staffs , such as couplings , hydraulic coupler , gear wheel , driving belt wheel , etc .
- ◆ All work such as inspection , maintenance and installation on gearbox should be done when gearbox is not in operation .
- ◆ No welding work should be done on gearbox , the gearbox musn ' t be used as an earthing point for welding work . Welding will cause irreparable damage to fine gear wheel and bearings .
- ◆ During assembly or disassembly work , the damaged bolts should be changed with new bolts with the same strength and category .
- ◆ If any changes are found during operation (for example , over heating or abnormal noise , etc) , you should switch off driving device immediately .
- ◆ Spare parts must be purchased from BONENG .
- ◆ The bad results caused by unreasonable application of couplings , self - modification to gear unit and application of the components of other companies are not included in " three - guarantee " services .

3 Installation and dismantlement

3.1 Notes before installation



- ◆ Confirm the gearbox in good condition (no damage during transporting or storing).
- ◆ Confirm site environment conforms to nameplate content.
- ◆ Standard ambient temperature of gearbox: -20°C~+50°C; no oil, acid, harmful gas, steam, radioactive substances. etc.
- ◆ If the storage time of gear unit is more than one year, the life of lubricant within the bearings will be shortened.



- ◆ Installing outdoor should avoid direct sunshine. In case of concentrated heat to influence smooth running of gearunit.
- ◆ Special gearbox: allocated according to ambient condition.
- ◆ During planning period, you should reserve enough space to maintain or repair.
- ◆ If the gearbox is fitted with a fan, there should be sufficient space for air intake.

3.2 Preparations

- ◆ Completely clean the preservative and pollutants, etc on the surface of input/output shaft and flange; be sure not to damage the oil sealing by solvents immersion.
- ◆ Preparation of tools/materials: one group of spanner, torque spanner, assembly clamp tools, input and output fastening device, lubricant (anti-rust oil), medium of sealing bolts (thread locking adhesives).

3.3 Installation of gearbox

Foundation

- ◆ Prepare rigid foundation or stable platform to install transmission device , It must be designed according to the mass and torque taking into account the forces acting on the gearbox . at the same time , you should consider that the position of all parts will not change even if maximum torque is loaded on units .
- ◆ The foundation of gearbox should be horizontal and leveled . The basic design should ensure that there is no resonance and no vibration transmitted from adjacent foundations.
- ◆ Fastening bolts or nuts must be tightened to the prescribed torque . For the correct torque, we recommend customer to use the bolts of the minimum strength class 8.8.

Lifting position

If the gearbox carry with lodcing disc,the locking dis must be axial fixed before swing.

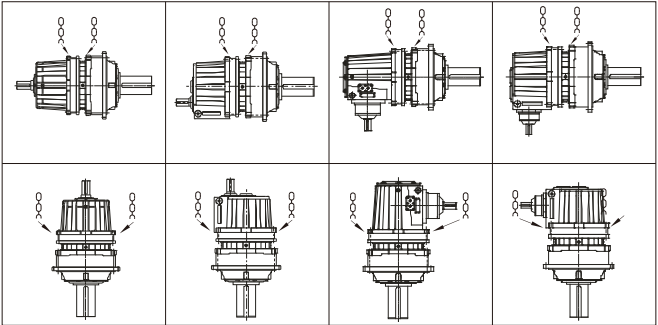

⚠ Note:Forbid to use the shaft end screw as the hoisting point after it is installed with hoisting ring.

According to different installation forms, you should pay attention to:

- ◆ For foundation installation, central height should be correct aligned, when connecting couplings, you should calibrate the coaxiality of the two shafts; for flexible couplings, the flotation value should not exceed the permissible range of couplings, for rigid connection, you should ensure form tolerance of each installation and connection; you should ensure shaft with enough rigidity for long shaft connection.
- ◆ When installing flange, protruding (or concave) steps should inosculate with housing. For flange installation and ollow shaft connection, ensure the contour and position tolerance for connection.
- ◆ When input shaft and output shaft of gearbox are installed with belt wheel or chain wheel, make sure the force transmission part of belt wheel or chain wheel be close to shaft shoulder as possible. As shown in the following diagram:
- ◆ Press the drive components into the outer screw of output shaft, knock should be avoided.

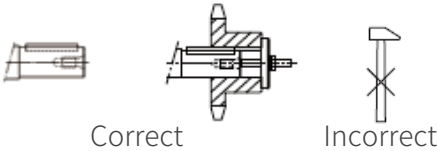

- ◆ When installing belt wheel or chain wheel, ensure input shaft is centered to driving device, ensure maximum axial deviation tolerance value of the four centering points in diagram be 1mm every 1000mm.

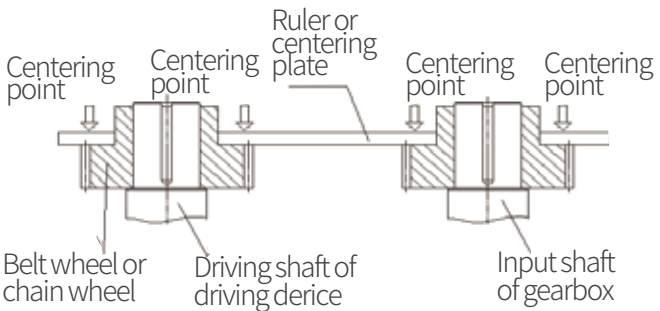

- ◆ When installing belt wheel or chain wheel, ensure belt wheel and chain with certain tonus.



3.4 Assembly of coupling

- ◆The input drive end of gearbox should apply flexible coupling or hydraulic coupling.
- ◆When output shaft of gearbox is solid shaft, you should apply flexible coupling.
- ◆If rigid coupling or other input and output elements which generate additional radial force or axial force (for example, gear wheel, belt wheel, fly wheel, hydraulic coupling, etc) are to be used, this should be marked in contract.
- ◆When input shaft is connected with driving shaft, ensure input shaft has the same axial center with driving shaft. Coaxiality deviation will increase mechanical vibration, cause damage to bearing and influence gear wheel contact. As shown in the following diagram, after input shaft is connected with driving shaft through coupling, you should adjust it with meter, after relevant inspection parameter satisfies the requirements in the following table “Coaxiality accuracy table”, the equipment can be used.

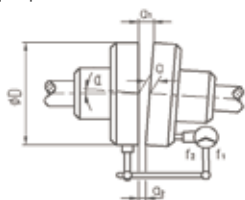

Angle deviation inspection

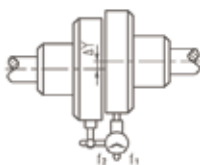

Deviation inspection

Coaxiality accuracy table:

D Outer diameter	n<500r/min		500~1500r/min		>1500r/min	
	a1-a2	ΔY	a1-a2	ΔY	a1-a2	ΔY
$D \leq 100$	0.05	0.05	0.04	0.04	0.03	0.03
$100 < D \leq 200$	0.06	0.06	0.05	0.05	0.04	0.04
$200 < D \leq 400$	0.12	0.10	0.10	0.08	0.08	0.06
$400 < D \leq 800$	0.20	0.16	0.16	0.12	0.12	0.10



Instruction:

When circular velocity of coupling outer diameter is 30m/s or below, it should be statically balanced. When circular velocity of outer diameter exceeds 30m/s, it must be dynamically balanced.

3.5 The installation and teardoun of locking plate

- ◆ When hollow shaft of gearbox is equipped with locking plate, you should first cover locking plate on hollow shaft, then finish the installation of driving shaft of driven device, you should not screw the fastening bolts on locking plate before installing the driving shaft of driven device.

⚠ →The locking plate being supplied can be directly installed, you can't tear it down before the first stress.

→Before installing locking plate, ensure the bore of hollow shaft and the machine shaft must be absolutely free of grease in the area of the shrink disk seat.

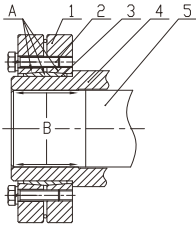

- 1 Outer ring
- 2 Fastening bolt
- 3 Inner ring
- 4 Hollow shaft
- 5 Driven shaft
- A Greased
- B Absolutely grease-free

- ◆ When screwing the bolts on locking plate, it is forbidden to screw it according to adjacent order, you should screw fastening bolts along with equilateral triangle order according to installation requirements of locking plate. During each circulated screwing process, each bolt can only screw 1/4 circle.
- ◆ In case of high temperature or vibration impact, please take anti-loosing measures on screw joints. The screw torque of each fastening bolt as follows:

Bolt	Tightening torque of bolt ($\mu=0.1$)		Bolt	Tightening torque of bolt ($\mu=0.1$)	
	strength Grade 10.9 Nm	strength Grade 12.9 Nm		strength Grade 10.9 Nm	strength Grade 12.9 Nm
M6	12	14.5	M20	470	570
M8	29	35	M24	820	980
M10	58	70	M27	1210	1450
M12	100	121	M30	1640	1970
M14	160	193	M33	2210	2650
M16	240	295	M36	2850	3420

- ◆ When disassembling the hollow shaft of gearbox equipped with locking plate, the loosening of locking plate is reversed to fastening direction. Finish disassembly of driving shaft of driven device according to the above method after tearing down locking plate.

When disassembling locking plate, you should pay attention :



→ It is forbidden to loose bolts according to the adjacent order.

→ When it is difficult to separate the outer and inner rings of the locking plate, several bolts can be screwed into the disassembly screw holes to push the inner and outer rings apart.

3.6 Torque reaction arm installation

- ◆ The torque reaction arm bears the torque from the driven machine.
- ◆ Torque arm on one side
- ◆ Using Torque reaction arm on one side for coupling bar, the self-aligning plain bearing or flexible bush must be used.

Torque Reaction Arm on One Side for Coupling Bar

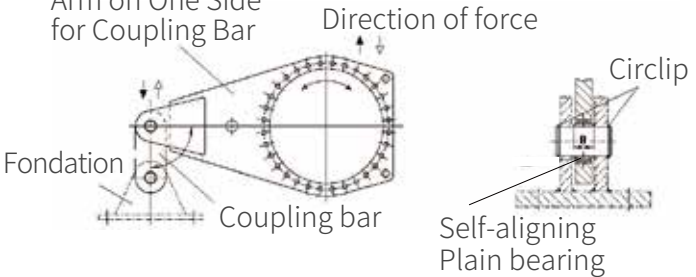

If need the detaile data, please consult the relative technical drawing about the gearbox.

Torsion shaft support

When using torsion shaft support, the torque is borne by bar and coupling bar, this structure ensures the bearing on the driven machine free of shearing force, except the weight itself. Below illustration is for your reference.

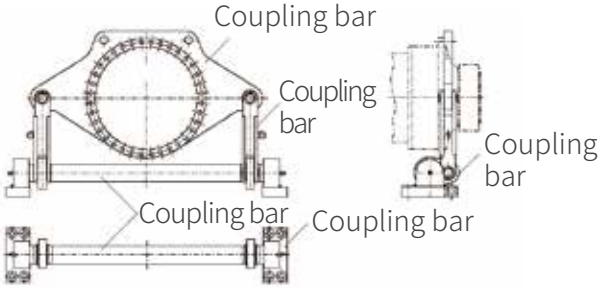

If need detailed data, please consult the technical drawing about gearbox.

The base for bearing can be mounted either on vertical wall or on horizontal foundation.





4 Mounting position

4.1 General description of mounting position

- ◆ The mounting position details and type selection, please refer BONENG selection manual.











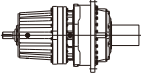
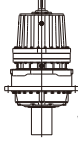
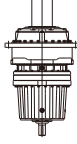

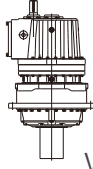
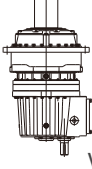







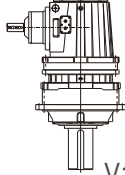
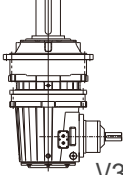



4.2 Specified description of mounting position

- ◆ The symbol of mounting position and its meaning:

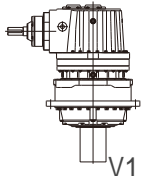
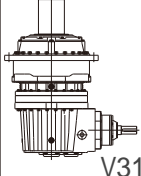
Symbol		Meaning	
		Breather	Oil filler
		Oil glass	
		Oil drain	

4.3 Identification of gearbox mounting position

It is possible to mount the gearbox in different positions; these are shown diagrammatically below as a drive shaft and are provided with an identification number:

		Horizontal	Vertical	
1 Coaxial	P.N.			
		B5	V1	V3
2 Helical -planetary	P.S.	  B51*		
		  B52		
		  B53		
		  B54		
		V11		
3 Bevel -planetary	P.L.	  B51*		
		  B52		
		  B53		
		  B54		
		V11		
4 Bevel -helical -planetary	P.K.	  B51*		
		  B52		
		  B53		
		  B54		
		V11		

5 Lubrication/Cooling/Heating

5.1 Lubrication

Lubrication selection:

- ◆ Under the premise of the same viscosity level and category, you can choose internationally famous brand.
- ◆ If you need to change the recommended viscosity level, please consult.
- ◆ The following table lists the lubrication oil brand and ambient temperature corresponding to product specification.

Ambient temperature°C	-20°C~+40°C
Viscosity brand number	VG320



◎When ambient temperature is lower than -10°C, you have to use synthetic oil.

◎To ensure lifespan of the products, we recommend synthetic oil.

◎When ambient temperature exceeds the above range, please consult technical department of BONENG.

Quantity of lubrication oil fill:

- ◆ This quantity is a recommended value. According to the difference of gear unit level and ratio, the oil filling quantity is different. Please pay attention to oil ruler scale as the indication of oil filling.

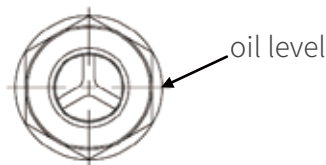

- ◆ Following table lists the suggested oil value according to the gearbox mounting position.

5.2 Oil quantity

Oil level (L)							
Type	P2N..	P2L..	P2S..	P2K..	P3N..	P3S..	P3K..
07	4	4	4	4	1	1	1
08	5	5	5	5	1	1	1
09	6	6	6	6	7	7	7
10	8	8	8	8	9	9	9
11	12	12	12	12	13	13	13
12	16	16	16	16	17	17	17
13	20	20	20	20	21	21	21
14	32	32	32	32	33	33	33
16	40	40	40	40	42	42	42
17	56	56	56	56	60	60	60
18	66	66	66	66	70	70	70
19	82	82	82	82	85	85	85
20	75	75	75	75	75	75	75
21	110	110	110		115	115	115
22	95	95	95		105	105	105
23	150	150	150		155	155	155
24	125	125	125		135	135	135
25	190	190	190		195	195	195
26	160	160	160		170	170	170
27	245	245	245		250	250	250
28	205	205	205		220	220	220
29	305	305	305		310	310	310
30	255	255	255		280	280	280
31	380		380		390	390	
32	315		315		360	360	
33	460		460		470	470	
34	380		380		480	480	
35	645		645				
36	535		535				

Note:

1) When ambient temperature is between -10°C ~ $+40^{\circ}\text{C}$, VG320 (ISO viscosity class) should be used for P series and accessory code is V32.

2) The oil level in the above table is the reference oil level for horizontal installation of the gearbox, and the reference oil level for vertical installation is approximately twice the corresponding data in the table;

5.3 Cooling

If required, planetary gearbox are fitted either with oil-water coolers or oil-air coolers. The required water connection must be provided by the user.

To ensure optimum cooling performance, the specified direction of flow in the cooling unit must be observed. The cooling-water inlet and outlet must not be reversed. The pressure of the cooling water must not exceed 8 bar.

If the gearbox is out of work for a longer period or if there is a danger of the water freezing, it must be drained off. Remove any remaining water with compressed air.

5.4 Cooling

For standard gearbox the working ambient temperature is $-20^{\circ}\text{C}\sim+50^{\circ}\text{C}$, when the temperature is under -10°C , it needs to be preheated or running without load. When the gearmotor temperature is over -10°C , gearbox can be operated with load.

5.5 Backstop

In some situations, the gearbox should equip mechanical backstop. This can make gearbox run to one direction during operation. The rotation direction is marked in input and output end of gearbox with arrow. Backstop mechanism is installed on mounting flange plate of gearbox, it is sealed, with no oil leakage. It is united with lubrication oil circulation system.

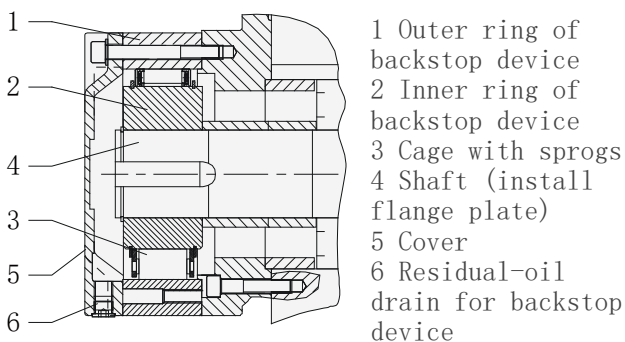

⚠ Note:

To avoid damaging backstop device or gearbox, the motor should not run to the forbidden direction, pay attention to the instruction on gearbox. Before motor wiring, you should determine rotation direction of three-phase power source with a phase-sequence indicator, connect motor wire according to the regulated rotation direction.

6 Application

6.1 Fill the lubrication oil

◆ Our products are not filled with lubrication oil when delivered. You should fill lubrication oil according to instruction book before running.

 On the position marked with this symbol, fill lubrication oil into gearbox.

6.2 Check the device

- ◆ Check oil level, cooling of lubrication oil or the sealingness of oil supply system.
- ◆ Inspect the status of cooling device and check the shut-off valve.
- ◆ For the gearbox equipped with backstop device, inspect whether wiring of motor is correct.
- ◆ Inspect whether shaft sealing is effective.
- ◆ Check whether the rotating components contact with other components.

6.3 Start

- ◆ For the gearbox equipped with motor oil pump, make sure open oil pump motor before starting the device.
- ◆ Check whether the running direction under free status is correct (supervise whether there is abnormal grinding noise when the shaft is running).
- ◆ During running inspection, you should ensure no output component on shaft, open relevant supervision and protection device at the same time.
- ◆ If there is abnormal running phenomenon (for example, temperature rise, noise, vibration, etc), you should turn off the motor and check out the reason.
- ◆ Contact with BONENG when necessary.

7 Checks and maintenance

7.1 Check and maintenance regularly

- ◆ Users should make regular maintenance to gearbox . Check the status of lubrication oil regularly, clean vent cap, fan, cooling coil and the surface of gear unit, keep the gearbox clean, ensure normal running of gearbox.

7.2 Periods of checks and maintenance

Check oil temperature	Daily
Check abnormal noise of gearbox	Daily
Check oil level	Monthly
Check for leaks gearbox	Monthly
Check oil for water content	After working 400 hours, at least once a year
First oil chang after starting	After working 400 hours
Subsequent oil changes	After every 5000 hours
Clean oil filter	Every 3 months
Clean ventilation cap	Every 3 months
Clean fan, fan cowl and gearbox cabinet	Do with oil changing
Check lubrication oil air cooler	Do with oil changing
Check lubrication oil water cooler	Do with oil changing
Check tightness of fastening bolts	The first time after changing oil, then change oil every two times
Full-aspect inspection to gearbox	About every 2 year, do with oil changing
Clean ventilation screw	Every 3 months

 The listed periods are determined on working condition of gearbox. These periods are average values under the following conditions:

- Daily working hour: 24 hours
- Loading factor: 100%
- Speed of input device 1500 RPM
- Maximum temperature 90°C (only mineral oil)
- 100°C (only synthetic oil)

7.3 Notes for checks and maintenance:

- ◆ Cut off power source, prevent electric shock, wait for cooling of gearbox.
Inspection of oil level: Please refer the oil glass level and fill the oil to the middle level of oil glass .
- ◆ Oil inspection: remove oil drain plug, take some samples, inspect oil viscosity index; if the oil is not clean, change it.
- ◆ Oil changing:
 - It is forbidden to mix different lubricants.
 - After cooling, oil viscosity will increase, it is harder to drain off oil. change before cooling.
 - Put an oil picking plate under oil plug, tear down oil plug ventilation cap, install oil plug after removing oil.
 - Inject new oil of the same brand, oil quantity should be the same with installation direction (see nameplate); if the brand number is different, consult after-sales department.
 - Inspect oil level at oil glass, install vent cap.

8 Fault treatment

8.1 Fault, reason and measures

Maintenance work should be done by qualified staff

Fault	Reason	Measure
Big noise at the fastener of gearbox	Fastener looses	Tighten bolt/nut Replace the damaged bolt/nut
Noise change of gearbox	Teeth of gear is damaged	Replace the damaged gear
	Bearing interval is too large	Adjust bearing interval
	Bearing is damaged	Replace the damaged bearings
Operating temperature is too high	Oil level in cabinet is too high.	Check and adjust oil level
	Oil is too old	Check and change oil
	Oil is badly contaminated.	Change oil
	Abnormal coolant flow rate	Adjust pipeline valves Check free flow rate of water cooling device
	Temperature of coolant is too high	Check the temperature and adjust according to requirements
	The oil filter of the water cooling device is blocked.	Clean oil filter
	Mechanical fault of oil pump	Check and replace the oil pump
	Serious contamination of fan cover and casing	Clean fan cover and cabinet

Fault	Reason	Measure
Temperature of bearing is too high	Abnormal oil level inside the tank	Adjust oil level
	Oil is too old	Check and change oil
	Mechanical fault of oil pump	Check and repair oil pump
	Bearing is damaged	Refer to standard vibration data Check and change bearings
Amplitude of bearing rises	Bearing is damaged	Check and change bearings
	Gear is damaged	Check and change gear
Check device temperature too high Function failure	Backstop device is damaged.	Check and change backstop
Gearbox leaks oil	Poor sealing	Check and replace the new oil seal Reseal the connection
	Radial shaft sealing ring is ineffective.	Replace radial seal
There is water in oil	Oil fams in pump	Check for moisture in the oil
	Lubrication oil cooler or cooling coil is ineffective	Check/repair the leakage location Change lubrication oil cooler/cooling coil
	Gear box frost	Protect the gearbox with insulation material Avoid direct blowing of cold air on the gearbox

Fault	Reason	Measure
Pressure supervision device alarms	Oil pressure is less than 0.5bar	Check oil level Check/change filter Check oil pump Repair/change oil pump
Indicator of double changing filter sends alarms	Double changing filter clogged	Switch filter Clean clogged filter element
Fault of oil supply system		View the fuel supply system description

For the faults can't be removed by customers, please contact with after-sales department of the company.

After-sale service

After-sales Service Please follow the steps below to submit the after-sales process.

→ Login “www.boneng.com”

→ Click “Service” and “After-sale Service”



→ Login system

[Email sign](#)

[New user registration](#)

Please enter email address

Please enter your password

Please enter the verification code



Sign in

Other District

Controller/Drive : 0512-66182005

Motor/Gear motor/Gearbox : 0512-66189918

BONENG TRANSMISSION(SHEN YANG)CO.,LTD

Controller/Drive : 024-31271571

Motor/Gear motor/Gearbox : 024-31292571

BONENG TRANSMISSION(TIAN JIN)CO.,LTD

Controller/Drive : 022-86928559

Motor/Gear motor/Gearbox : 022-26929558

BONENG TRANSMISSION(KAIFENG)CO.,LTD

Controller/Drive : 0371-23335230

Motor/Gear motor/Gearbox : 0371-23277771

BONENG TRANSMISSION(WEIFANG)CO.,LTD

Controller/Drive : 0536-4699687

Motor/Gear motor/Gearbox : 0536-4699667

BONENG TRANSMISSION(CHANGSHA)CO.,LTD

Controller/Drive : 0731-88386958

Motor/Gear motor/Gearbox : 0731-88380725

**BONENG TRANSMISSION EQUIPMENT
(CHENGDU)CO.,LTD**

Controller/Drive : 028-87740066

Motor/Gear motor/Gearbox : 028-87740066

BONENG TRANSMISSION(ZHAOQING)CO.,LTD

Controller/Drive : 0757-86719757

Motor/Gear motor/Gearbox : 0758-2699830

BONENG TRANSMISSION(SUZHOU)CO.,LTD

Controller/Drive Southern Jiangsu : 0512-66182005

Motor/Gear motor/Gearbox Southern Jiangsu :

0512-66189918

Controller/Drive Zhejiang-Shanghai : 0512-66182005

Motor/Gear motor/Gearbox Zhejiang-Shanghai :

0512-66189918

Controller/Drive Jiangsu-Anhui District : 0512-66182005

Motor/Gear motor/Gearbox Jiangsu-Anhui : 025-52171612

BONENG TRANSMISSION(USA/Canada)CO.,LTD

Technical Support/Debugging/After-Sales Service :

1250 E 222nd Euclid, OH 44117, United States

Email: America@boneng.com

Office Tel: 1-216-618-3099 / 1-216-618-0138

BONENG TRANSMISSION(India)CO.,LTD

Technical Support/Debugging/After-Sales Service :

Plot No. E-10/3, MIDC sinner (Malegaon) Industrial Area,

Nashik, 422123, Maharashtra, India.

Email: india@boneng.com

Tel: +91-22-2781 3385 / +91-11- 4507 6293

BONENG